

## Zemin Profilleri L=3 m / Floor Profiles L=3 m

- \*Malzeme: Gümüş eloksallı alüminyum
- \*Alüminyum standardı: ETIAL 60,DIN AIMgSi 0.5
- \*Kaplama: 8-10 mikron kalınlıkta gümüş rengi eloksal
- \*Standart boy: 3mt
- \*Montaj şekli: Paslanmaz çelik yay, butil bant veya tek taraftan vida ile
- \*Vida deliksiz olarak teslim edilir.
- \*Müşteri talep ederse, kullanılacak vidaya uygun havşabaş delik açılır.

- \*Material: Silver anodized aluminium
- \*Aluminium standard: ETIAL 60,DIN AIMgSi 0.5
- \*Coating: 8-10 um thick silver color anodizing
- \*Standard length: 3m
- \*Fixation: with stainless steel clips or with screw on one side and butyl tape
- \*Delivery: Without screw holes.Upon request of customers,profiles can be delivered with pre-drilled counterbored screw holes

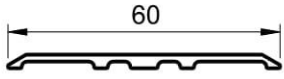
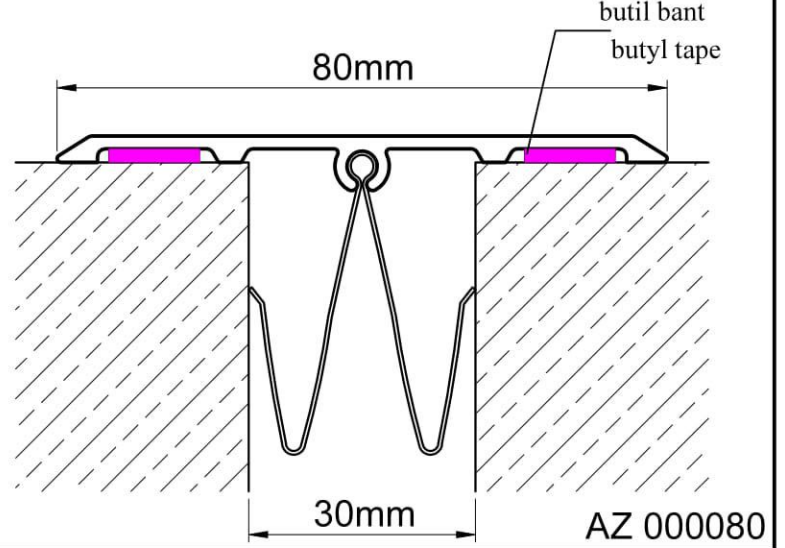

AZ 000060

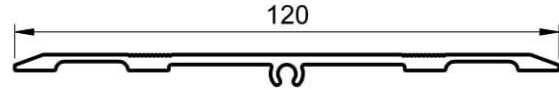

AZ 000120

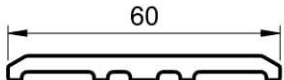

AZ 000061

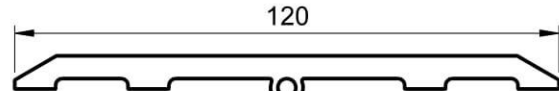

AZ 000121

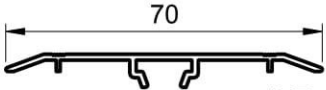

AZ 000070

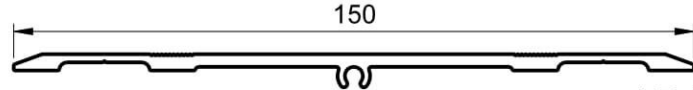

AZ 000150

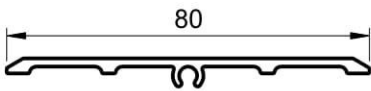

AZ 000080

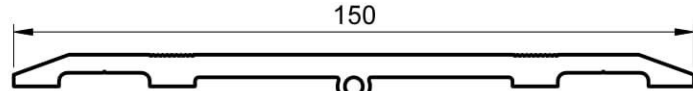

AZ 000151

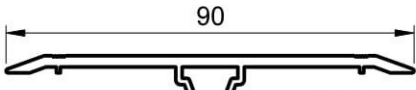

AZ 000090

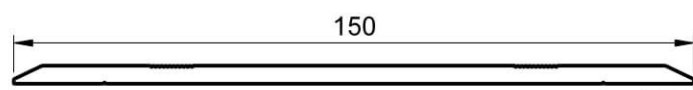

AZ 000154

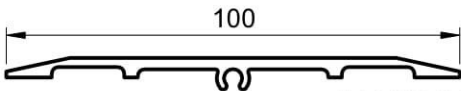

AZ 000100

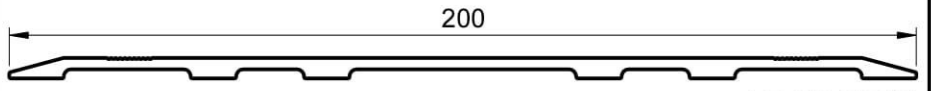

AZ 000200

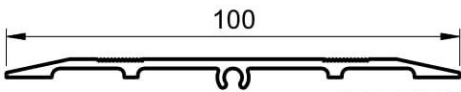

AZ 000101

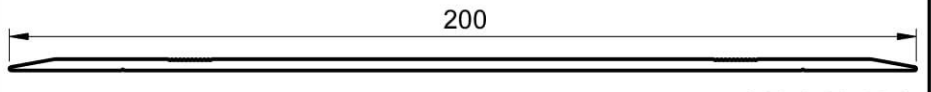

AZ 000201

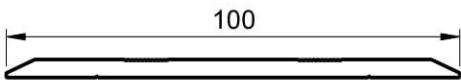

AZ 000104

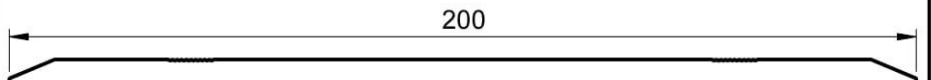

AZ 000202

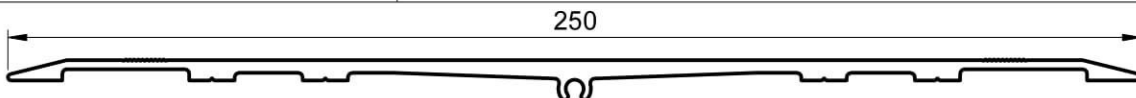

AZ 000250